



ALKHALEFAH
FASTENERS



Our production takes place in our site in Riyadh, Saudi Arabia, it is a modern production line using automatic cold forming machines with a capacity of 800 Ton per year. We produce all kinds of products of standard and non-standard dimensions, also we produce according to special customer requirements in a very short period of time. We have our own automatic zinc plating line for surface protection to avoid corrosion.

All products are subject to intensive testing to make sure that customers receive the highest quality at competitive prices.

يتم إنتاجنا في موقعنا بالرياض ، المملكة العربية السعودية ، وهو عبارة عن خط إنتاج حديث يستخدم آلات التشكيل البارد الأوتوماتيكية بسعة 800 طن في السنة. نحن ننتج جميع أنواع المنتجات ذات الأبعاد القياسية وغير القياسية ، كما ننتج وفقاً لمتطلبات العملاء الخاصة في فترة زمنية قصيرة جداً. لدينا خط طلاء الزنك الأوتوماتيكي الخاص بنا لحماية السطح لتجنب التآكل.

تخضع جميع المنتجات لاختبارات مكثفة للتأكد من حصول العملاء على أعلى جودة وبأسعار تنافسية.

أنواع الرأس Head Types

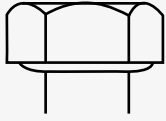

HEX CAP

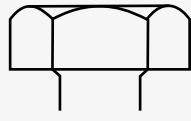

HEX HEAD

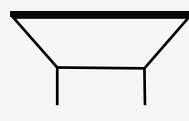

FLAT COUNTERSUNK

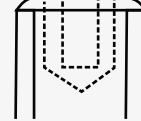

HEX SOCKET SET

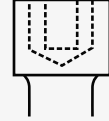

HEX SOCKET CAP

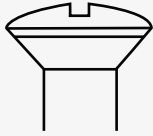

RAISED COUNTERSUNK



HEX FLANGE

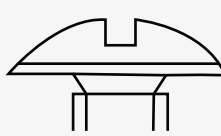

TRUSS

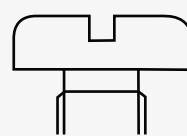

PAN

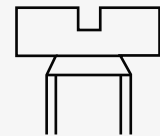

CHEESE

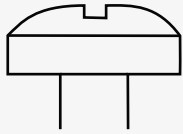

PAN

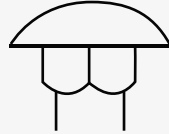

MASHROOM HEAD
SQUARE NECK

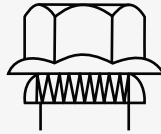

HEX FLANGE WITH
NEOPRENE WASHER

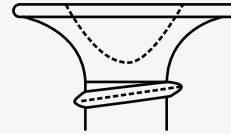

BUGLE

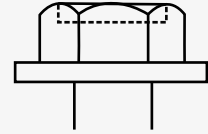

HEX WASHER HEAD

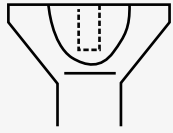

FLAT COUNTERSUNK

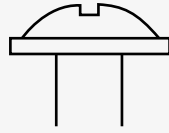

TRUSS

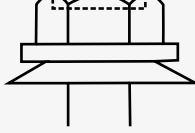

HEX WASHER HEAD
WITH BOUNDED WASHER

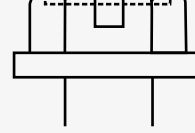

HEX WASHER HEAD

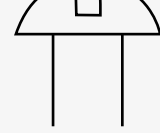

ROUND HEAD

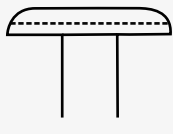

FLAT HEAD

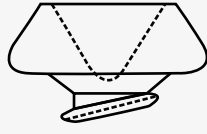

PAN FRAMING

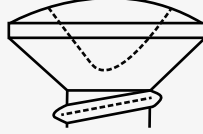

OVAL

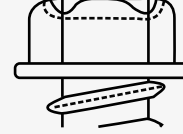

H.W.H

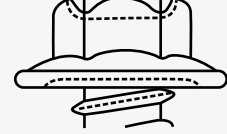

H.W.F

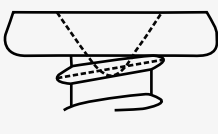

PAN CAKE

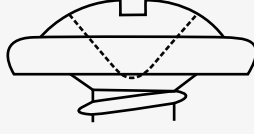

TRUSS

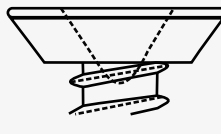

HINGE

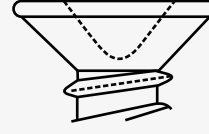

C.S.K

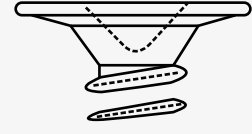

LARGE WAFER

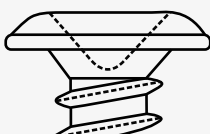

WAFER

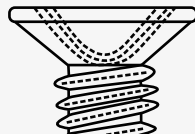

PHILLIPS

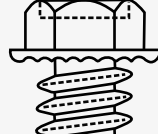

HEX SERRATION

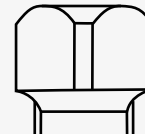

SPLINE



LIFTING EYE



DIN 975

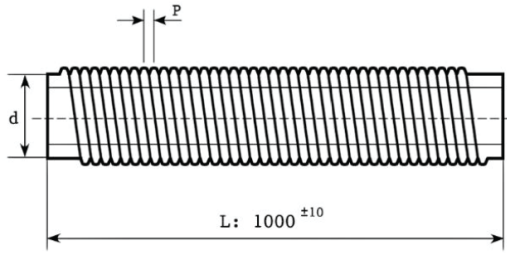

Threaded rods

d	M3	M4	M5	M6	M8	M10	M12	M14	M16	M18	M20
p	0.5	0.7	0.8	1	1.25	1.5	1.75	2	2.5	2.5	2.5
d	M22	M24	M27	M30	M33	M36	M39	M42	M45	M48	M52
p	2.5	3	3	3.5	3.5	4	4	4.5	4.5	5	5

ASTM A193

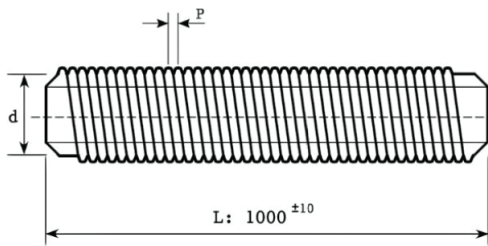

Studbolts ASTM A193

d pitch / inch	1/2	5/8	3/4	7/8	1"	1" 1/8	1" 1/4
Thread per inch	13	11	10	9	8	8	8
d pitch / inch	1" 3/8	1" 1/2	1" 5/8	1" 3/4	1" 7/8	2"	
Thread per inch	8	8	8	8	8	8	

"U"-Bolts

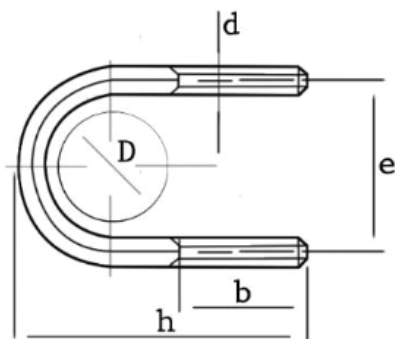

U-Bolts



Anchor "L" Bolts

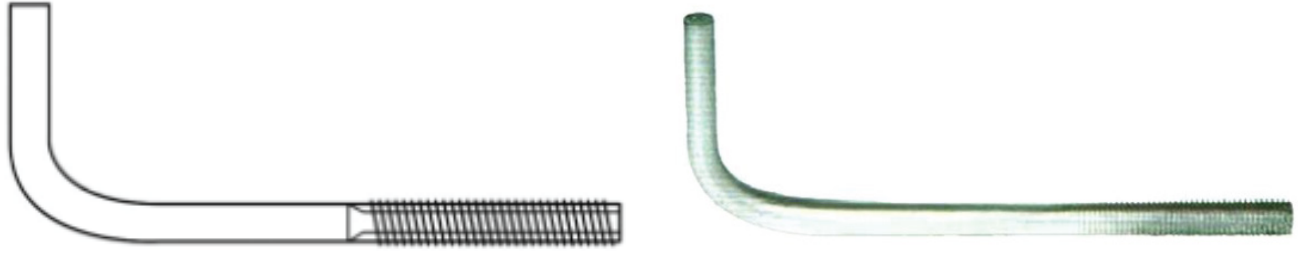

L-Bolts

Anchor "J" Bolts



J-Bolts

Eye Lifting Bolts



Male Type
DIN 580

Female Type
DIN 582

Male & female - Eye lifting bolts

Flat Head Bolts



Flat head bolts



Anchor Bolts-One side

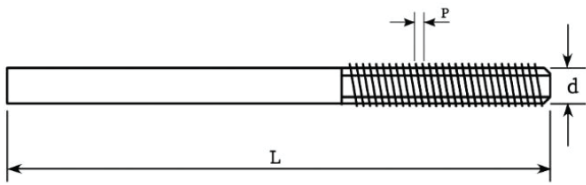

Threaded rods - One side

d	M3	M4	M5	M6	M8	M10	M12	M14	M16	M18	M20
p	0.5	0.7	0.8	1	1.25	1.5	1.75	2	2	2.5	2.5
d	M22	M24	M27	M30	M33	M36	M39	M42	M45	M48	M52
p	2.5	3	3	3.5	3.5	4	4	4.5	4.5	5	5

Anchor Bolts-Both Side

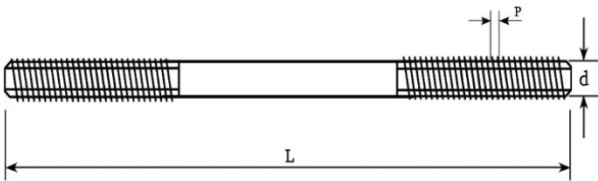

Threaded rods - One side

d	M3	M4	M5	M6	M8	M10	M12	M14	M16	M18	M20
p	0.5	0.7	0.8	1	1.25	1.5	1.75	2	2	2.5	2.5
d	M22	M24	M27	M30	M33	M36	M39	M42	M45	M48	M52
p	2.5	3	3	3.5	3.5	4	4	4.5	4.5	5	5

Safety Lock

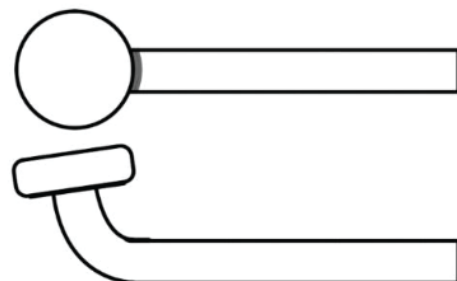
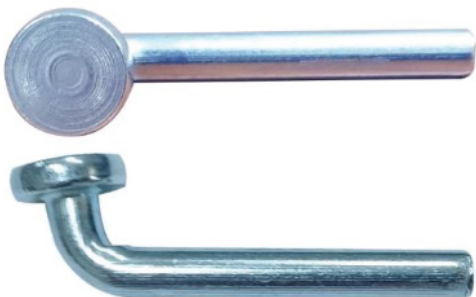

Safety Lock



DIN 931

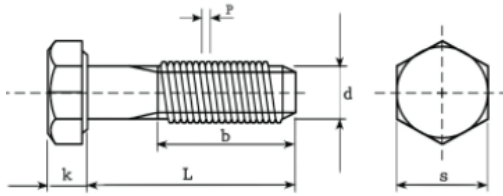

Hexagon head bolts									
d	M4	M5	M6	M7	M8	M10	M12	M14	
P	0.7	0.8	1	1	1.25	1.5	1.75	1.75	
(1)	14	16	18	20	22	26	30	34	
d ⁽¹⁾	(2)	-	22	24	26	28	32	36	40
		-	-	-	-	45	49	53	
k	2.8	3.5	4	4.8	5.3	6.4	7.5	8.8	
s	7	8	10	11	13	17/16*	19/18*	22/21*	

DIN 933

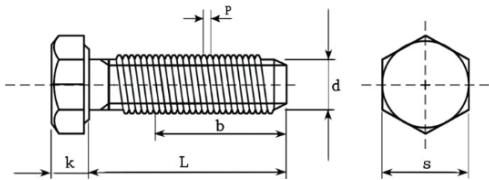

Hexagon head bolts - Fully threaded							
d	M33	M36	M39	M42	M45	M48	M52
P	3.5	4	4	4.5	4.5	5	5
k	21	22.5	25	26	28	30	33
s	50	55	60	65	70	75	80

Square Bolts

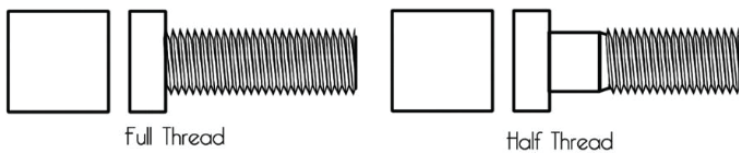

Square bolts



DIN 960

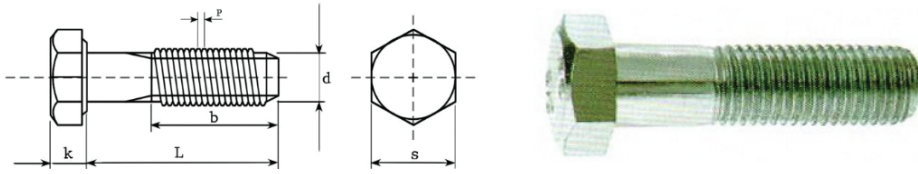

Hexagon head bolts - Metric pitch thread

dxP	M8x1	M10x1	M12x1.25	M14x1.5	M16x1.5	M18x1.5	M20x1.5	M22x1.5	M24x1.5
		M10x1.25	M12x1.5			M18x2	M20x2	M22x2	M24x2
b ¹	1	22	26	30	34	38	42	46	50
	2	28	32	36	40	44	48	52	56
k		5.3	6.4	7.5	8.8	10	11.5	12.5	14
s		13	17/16*	9/18*	22/21*	24	27	30	32/34*

DIN 961

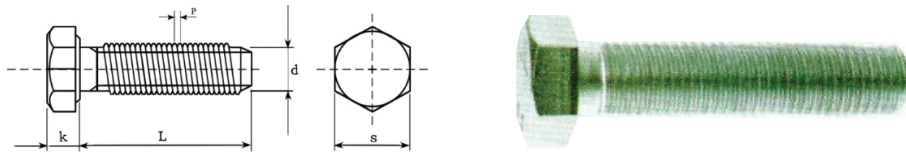

Hexagon head bolts - Metric pitch thread

dxP	M8x1	M10x1	M12x1.25	M14x1.5	M16x1.5	M18x1.5	M20x1.5
		M10x1.25	M12x1.5			M18x2	M20x2
k		5.3	6.4	7.5	8.8	10	11.5
s		13	17/16*	19/18*	22/21*	24	27

DIN 6914

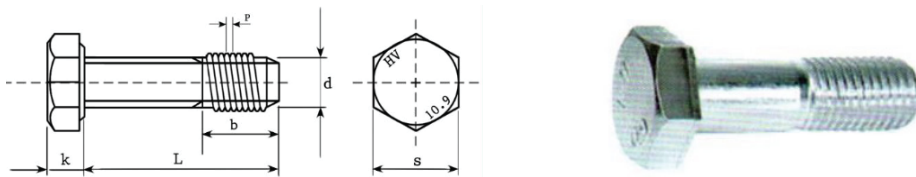

High strength structural bolt (HV)

dxP	M12	M16	M20	M22	M24	M27	M30	M36
P	1.75	2	2.5	2.5	3	3	3.5	4
b	(1)	21	26	31	32	34	37	48
	(2)	23	28	33	34	37	39	50
k		8	10	13	14	15	17	23
s		22	27	32	36	41	46	60

مسامير سداسية الرأس مشقوقة Hex Slotted Head Bolts



DIN 933

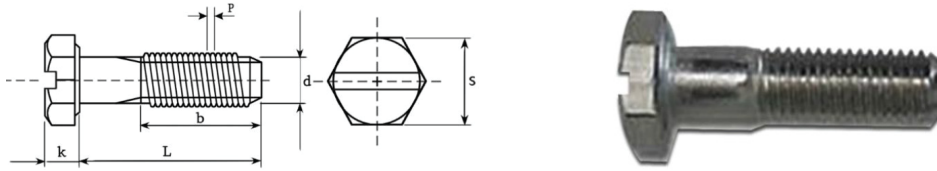

Hexagon slotted head bolts - Metric pitch thread

dxP	M8x1	M10x1	M12x1.25	M14x1.5	M16x1.5	M18x1.5	M20x1.5	M22x1.5	M24x1.5
		M10x1.25	M12x1.5			M18x2	M20x2	M22x2	M24x2
b ¹	1	22	26	30	34	38	42	46	50
	2	28	32	36	40	44	48	52	56
k		5.3	6.4	7.5	8.8	10	11.5	12.5	14
s		13	17/16*	9/18*	22/21*	24	27	30	32/34*

DIN 933

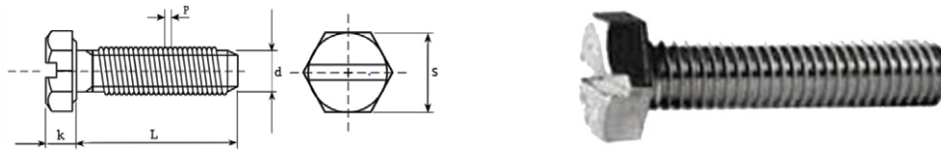

Hexagon head bolts - Metric pitch thread

dxP	M8x1	M10x1	M12x1.25	M14x1.5	M16x1.5	M18x1.5	M20x1.5
		M10x1.25	M12x1.5			M18x2	M20x2
k		5.3	6.4	7.5	8.8	10	11.5
s		13	17/16*	19/18*	22/21*	24	27

Hex Knurling Bolts

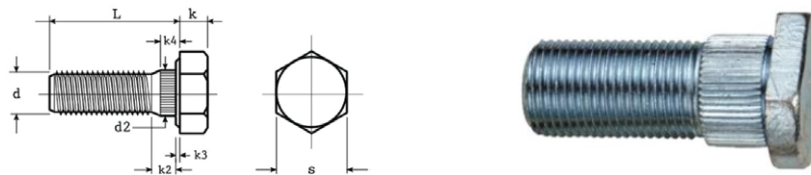

Hex knurling bolts

dxL	M10x30	M10x35	M10x40	M10x50	M12x35	M12x40	M12x50
k					7.5		
s					19		
d2					13.2		
k2					66		
k3					05		

قضبان ملولبة ومسامير تثبيت Carriage Bolts



DIN 603

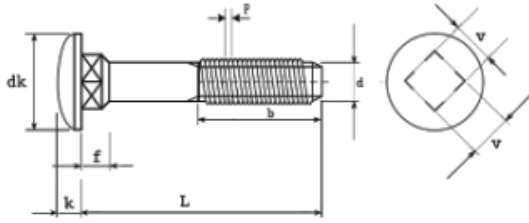

Mushroom head square neck (cap square neck bolts)

d	M5	M6	M8	M10	M12	M16	M20
p	0.8	1	1.25	1.5	1.75	2	2.5
b	1	16	18	22	26	30	38
	2	22	24	28	32	36	44
	3	-	-	41	45	49	57
dk(max)	13.55	16.55	20.65	24.65	30.65	38.8	46.8
f(max)	4.1	4.6	5.6	6.6	8.75	12.9	15.9
k(max)	3.3	3.88	4.88	5.38	6.95	12.9	11.05
v(max)	5.48	6.48	8.58	10.58	12.7	16.7	20.84

DIN 604

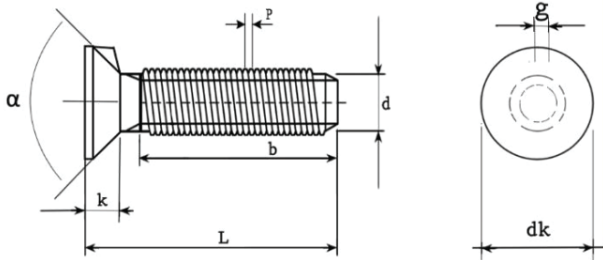

Flat countersunk nib bolts

d	M6	M8	M10	M12	M16	M20	M24
p	1	1.25	1.5	1.75	2	2.5	3
b ⁽¹⁾	1	18	22	26	30	38	46
	2	24	28	32	36	44	52
	3	-	41	45	49	57	65
dk(max)	12.55	16.55	19.65	24.65	32.8	32.8	38.8
k(max)	4	5	5.5	7	9	11.5	13
g(max)	2.5	3	3.2	3.6	4.2	5.4	6.6
alpha(max)	90*	90*	90*	90*	90*	60*	60*

قضبان ملولبة ومسامير تثبيت Carriage Bolts



DIN 605

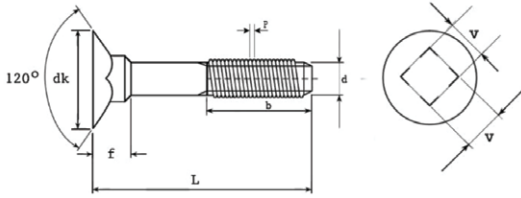

Flat countersunk square neck bolts

d	M6	M8	M10
p	1	1.25	1.5
b	18	22	26
dk(max)	16.55	20.65	24.65
f(max)	7.45	9.45	11.55
v(max)	6.48	8.58	10.58

DIN 608

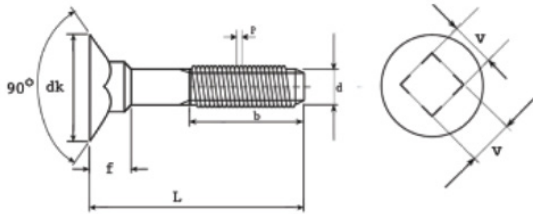

Flat countersunk square neck bolts

d	M10	M12
p	1.5	1.75
b	26	30
dk(max)	19.65	24.65
f(max)	8.45	11.05
v(max)	10.58	12.7

قضبان ملولبة ومسامير تثبيت Allen Key Bolts



DIN 912

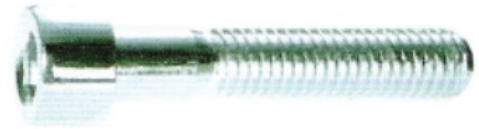
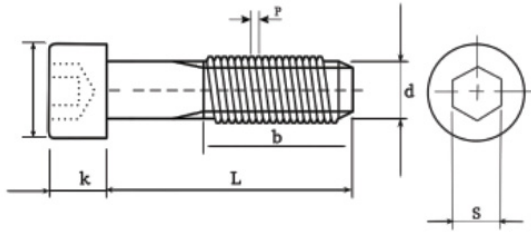

Hexagon socket head cap screws

d	M3	M4	M5	M6	M8	M10	M12	M14	M16	M18
p	0.5	0.7	0.8	1	1.25	1.5	1.75	2	2	2.5
b*	18	20	22	24	28	32	36	40	44	48
dk(max)	5.5	7	8.5	10	13	16	18	21	24	27
k(max)	3	4	5	6	8	10	12	14	16	18
s	2.5	3	4	5	6	8	10	12	14	14

DIN 7991

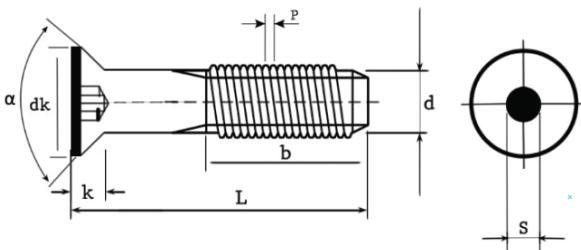

Hexagon socket countersunk head screws

d	M3	M4	M5	M6	M8	M10	M12	M16	M20
p	0.5	0.7	0.8	1	1.25	1.5	1.75	2	2.5
b*	12	14	16	18	22	26	30	38	46
dk(max)	6	8	10	12	16	20	24	30	36
k(max)	1.7	2.3	2.8	3.3	4.4	5.5	6.5	7.5	8.5
α	90°	90°	90°	90°	90°	90°	90°	90°	90°
s	2	2.5	3	4	5	6	8	10	12



DIN 964

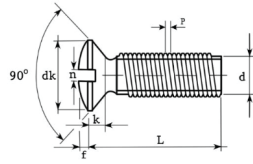

Slotted raised countersunk head screws

d	M3	M4	M5	M6	M8
P	0.5	0.7	0.8	1	1.25
dk	5.6	7.5	9.2	11	14.5
k (max)	1.65	2.2	2.5	3	4
f	0.75	1	1.25	1.5	2
n	0.8	1	1.2	1.6	2

DIN 965

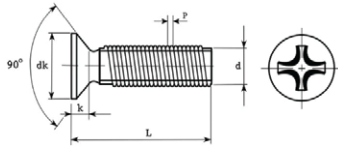

Flat head phillips countersunk screws

d	M3	M4	M5	M6	M8
P	0.5	0.7	0.8	1	1.25
dk	5.6	7.5	9.2	11	14.5
k (max)	1.65	2.2	2.5	3	4
Nr. Phillips (H)	1	2	2	3	4

DIN966

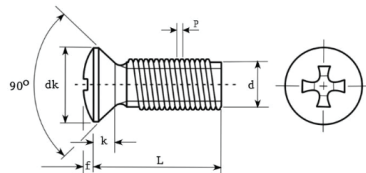

Pan head philips countersunk screws

d	M3	M4	M5	M6	M8
P	0.5	0.7	0.8	1	1.25
dk	5.6	7.5	9.2	11	14.5
k (max)	1.65	2.2	2.5	3	4
Nr. Phillips (H)	1	2	2	3	4



DIN 7984

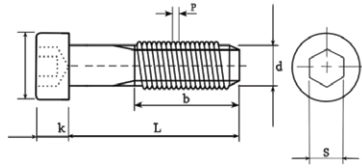

Hexagon socket head cap screws with low head

d	M3	M4	M5	M6	M8	M10	M12	M14	M16	M18	M20	M22	M24
P	0.5	0.7	0.8	1	1.25	1.5	1.75	2	2	2.5	2.5	2.5	3
b*	12	14	16	18	22	26	30	34	38	42	46	50	54
dk	5.5	7	8.5	10	13	16	18	21	24	27	30	33	36
k	2	2.8	3.5	4	5	6	7	8	9	10	11	12	13
s	2	2.5	3	4	5	7	8	10	12	12	14	14	17

DIN 7985

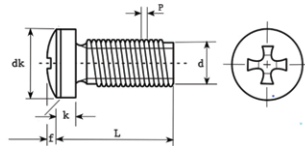

Cheese head phillips screws

d	M3	M4	M5	M6	M8
P	0.5	0.7	0.8	1	1.25
dk	6	8	10	12	16
k	2.4	3.1	3.8	4.6	6
Nr. Phillips	1	2	2	3	4

DIN 6921

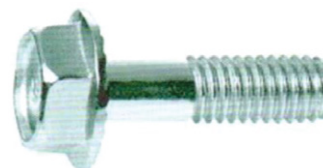
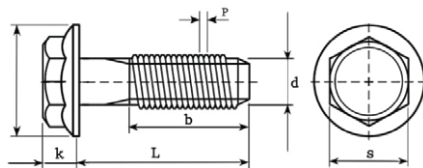

Pan head philips countersunk screws

d	M5	M6	M8	M10	M12	M14	M16	M20
P	0.8	1	1.25	1.5	1.75	2	2	2.5
b	16	18	22	26	30	34	38	46
k	5.40	6.6	8.1	9.2	11.5	12.8	14.4	17.1
s	8	10	13	15	16	18	21	27
dc	11.8	14.2	18	22.3	26.6	30.5	35	43



DIN 571

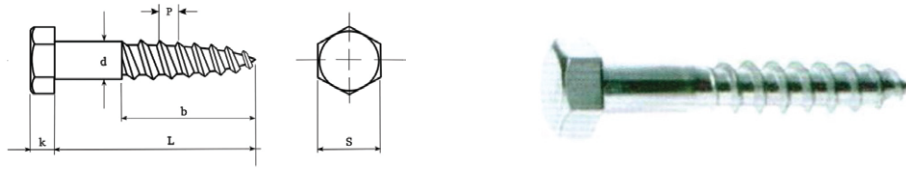

Hexagon head wood screws

d	5	6	8	10	12	16	20
k	3.5	4	5.5	7	8	10	13
s	8	10	13	17	19	24	30

DIN 97



Slotted countersunk (flat) head wood screws

ds	2	2.5	3	3.5	4	4.5	5	6
P	3.8	4.7	5.6	6.5	7.5	8.3	9.2	11
k (max)	1.2	1.5	1.55	1.93	2.2	2.35	2.5	3
n	0.5	0.6	0.8	0.8	1	1	1.2	1.6

DIN966

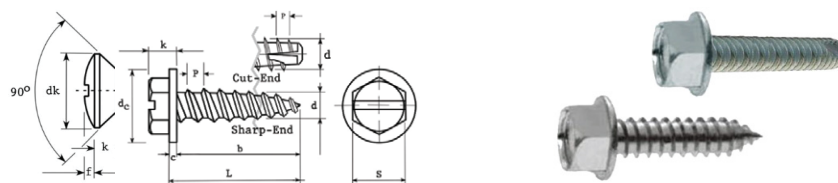

Hexagon washer head with one slot tapping screws

d	ST 3.5	ST 4.2	ST 4.8	ST 6.3
P	0.5	1.4	1.6	1.8
dc mini	5.6	8.1	9.8	12.2
dc max	1.65	8.8	10.5	13.5
k	1	2.8	3.1	4.95
c	5.6	0.6	0.7	0.9
s	1.65	7	8	10
Ne.ISO	6	8	10	14